

Product Details

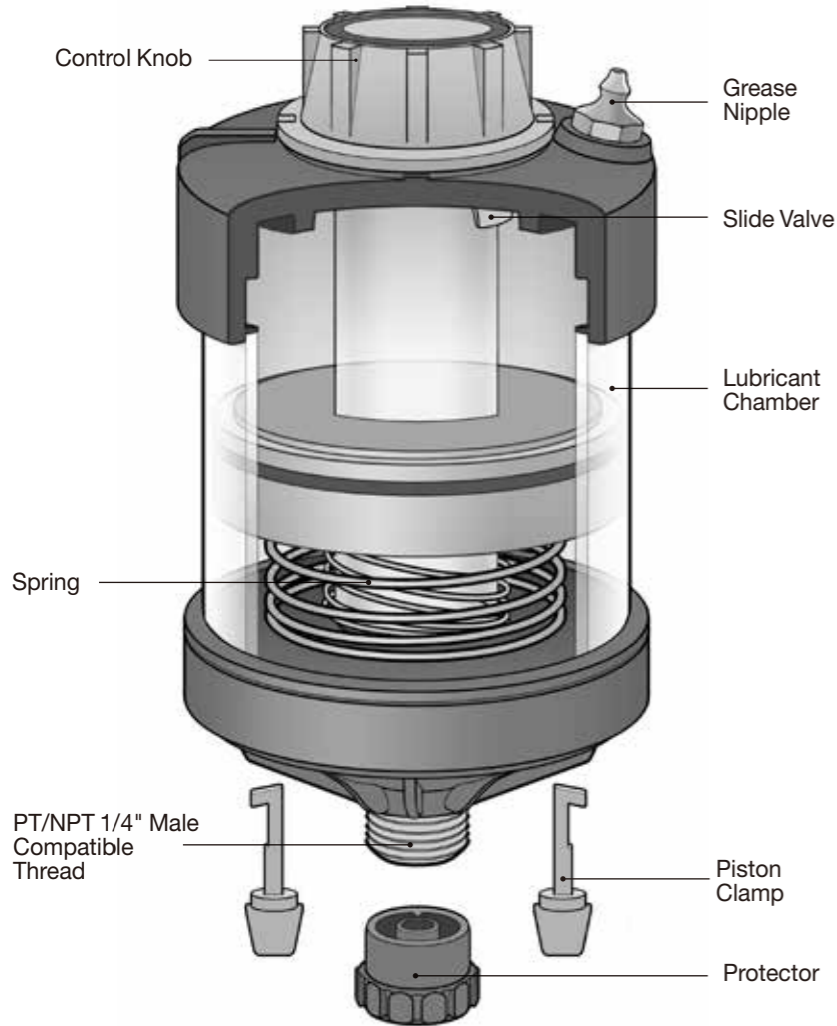

Installation Guidelines

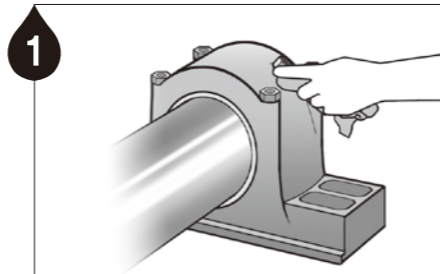

1 Remove contaminants around the lube point.

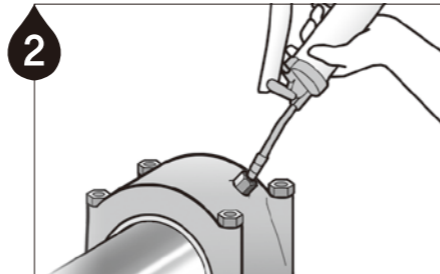

2 Ensure a clear passage using a manual grease gun. **Note 1** Remove any hardened grease by purging the lube point with a manual grease gun. **Note 2** The grease in the equipment and the grease contained in the unit should be the same or compatible.

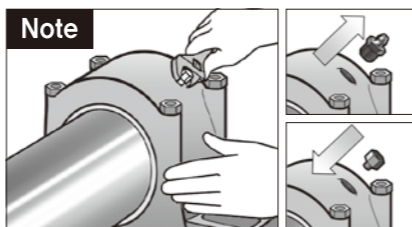

Note Remove the grease nipple and install appropriate adaptors.

For Pre-Filled Pulsarlube S

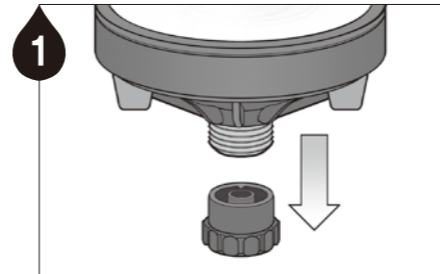

1 Remove the protector.

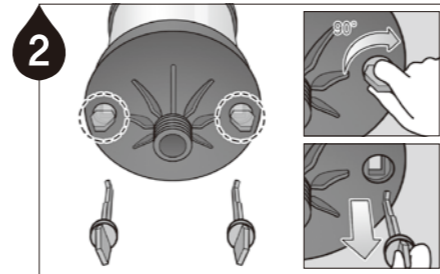

2 Turn and pull out the piston clamps found at the bottom of the lubricator.

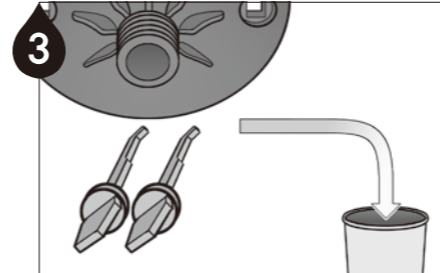

3 Dispose of the piston clamps removed from the lubricator.

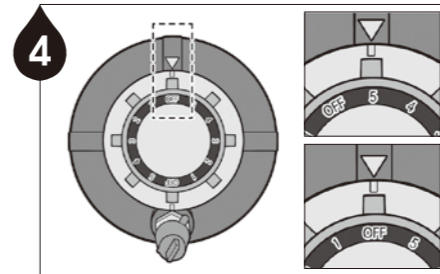

4 Turn the control knob to #5 to make sure the lubricator is dispensing properly. After checking, turn the control knob back to 'OFF' position.

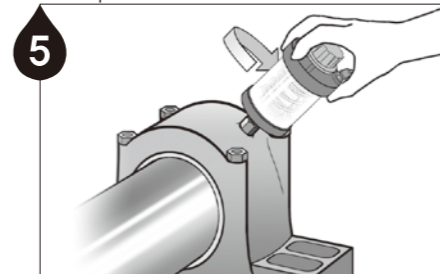

5 Install the Pulsarlube S unit on the lube point.

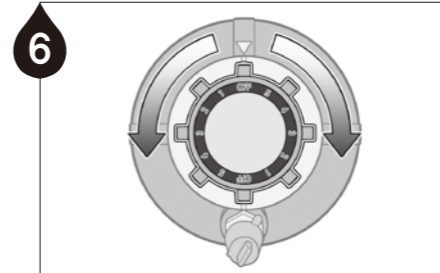

6 Set it to the desired dispensing rate from #1 through #5.

To Fill the Pulsarlube S

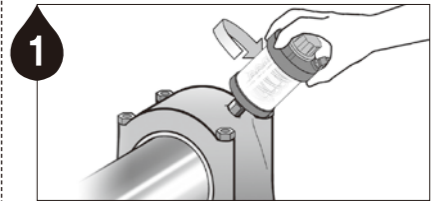

1 Install the Pulsarlube S unit on the lube point for easy filling of grease.

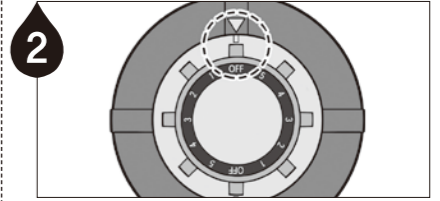

2 Set the control knob to 'OFF' position before filling the lubricator.

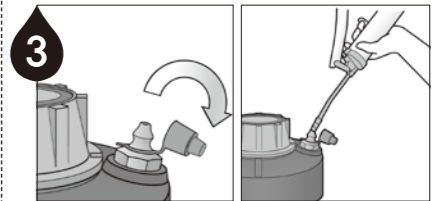

3 Remove the red grease cap and fill lubricator until the piston ring reaches level indicator line that reads "Do not fill below this line". Refer to the grease filling information on the back.

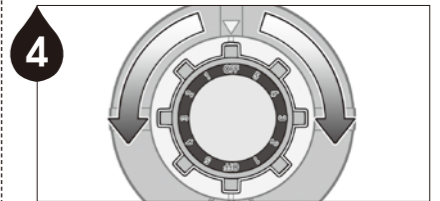

4 Set it to the desired dispensing rate from #1 through #5.

Grease Filling Information

- ▶ Do not fill or refill with a high pressure or high volume pneumatic or electrically operated grease gun.
- ▶ When filling with a grease gun, remove the air inside of the reservoir by letting grease discharge through the center sleeve of the lubricator.



- ▶ Overfilling may cause damage to the lubricator. Fill the lubricator until the piston ring reaches the level indicator line that reads "Do not fill below this line".

Precautions

- ▶ The Pulsarlube S is not a time programmable lubricator. For best performance, ensure proper operation by keeping a log of periodic dispensing activities.
- ▶ Consider the existing backpressure at the lubepoint and ambient temperature conditions when selecting the control knob position.
- ▶ If there is no change in grease level or the lube point has not been checked for a long time.

1. Make sure the control knob is set to 'OFF' and remove the lubricator from the lube point.
2. Turn the control knob to #5 to make sure the lubricator is dispensing properly.
3. Allow the remaining grease to drain completely before refilling the unit. Try repeating steps above if grease does not dispense or drain.
4. If remaining grease does not dispense due to grease hardening, please discard the lubricator.
5. Refill the unit and reset the control knob to the desired position and check the lubricator for proper operation.

Mounting Methods

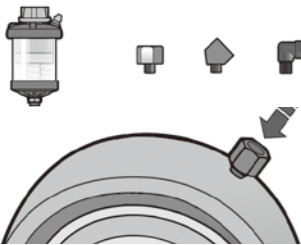

The Pulsarlube S is designed for single point lubrication only. Direct mount is always preferable.

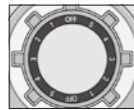

- ▶ The position of the control knob represents the flow level generated by the valve.

Shelf life and Product Warranty Warranty is limited to original defects in material and workmanship and will not cover any collateral damage due to mishandling, abuse and /or any other inappropriate use of this product. Warranty period is 1 year from the date of purchase.

PULSARLUBE

The World Leader of Automatic Lubrication

Pulsarlube USA, Inc.

1480 Howard Street, Elk Grove Village, IL 60007, USA
TEL:1-847-593-5300 FAX:1-847-593-5303 www.pulsarlube.com / info@pulsarlube.com

